



ZBA Inc.



User's manual



ZBA, Inc.
94 Old Camplain Road Hillsborough, NJ 08844
Ph: 908-359-2070 Fax: 908-595-0909
Web: <http://www.zbausa.com>



ZBA Inc.

Important Notice

No warranty of any kind is made in regard to this material, including, but not limited to, implied warranties of merchantability or fitness for a particular purpose. We are not liable for any errors contained herein or incidental or consequential damages in connection with furnishing, performance or use of this material.

No part of this document may be reproduced, transmitted, stored in a retrieval system, transcribed, or translated into any language or computer language in any form or by any means electronic, mechanical, magnetic, optical, chemical, manual or otherwise, without express written consent and authorization.

We reserve the right to make changes in product design without reservation and without notification. The material in this guide is for information only and is subject to change without notice.

All trademarks mentioned herein, registered or otherwise, are the properties of their various respective owners.

Copyright © 2009. All rights reserved.

For CE-countries

This scanner is in conformity with CE standards. Please note that an approved, CE-marked power supply unit should be used in order to maintain CE conformance.

ZBA, Inc.

94 Old Camplain Road Hillsborough, NJ 08844

Ph: 908-359-2070 Fax: 908-595-0909

Web: <http://www.zbausa.com>



Table of Contents

- 1. Instruction1
- 2. Outline.....2
- 3. Mounting Recommendations.....3
- 4. Interface Selection7
- 5. Blink Mode9
- 6. TEST Button Function9
 - 12.1** 5-1 Trigger Mode..... 10
 - 12.2** 5-2 Scan Performance Test Mode 10
- 7. Technical Specification 11
- 8. Dimension 13
- 9. Maintaining the Scanner 14
- 10. Programming Guide 15
 - 12.3** Programming Procedure 15
 - 12.4** Table 1: Factory Default Settings 17
 - 12.5** Table 2: Default Data Transmit Format..... 18
 - 12.6** Table 3: Trigger Command Format 19
- 11. Parameter setting..... 20
 - 11.1. System Function Setting..... 20
 - 11.2. Scan Function Setting..... 22
 - 11.3. “TEST” Button Function Setting 22
 - 11.4. Interface Setting..... 23

ZBA, Inc.
94 Old Camplain Road Hillsborough, NJ 08844
Ph: 908-359-2070 Fax: 908-595-0909
Web: <http://www.zbausa.com>



ZBA Inc.

- 11.5. HID USB Keyboard Wedge Setting 23
- 11.6. RS-232 Interface Setting..... 24
- 12. The Symbologies Settings..... 28
 - 12.1 Codabar 28
 - 12.2 Code 39..... 29
 - 12.3 Code 93..... 31
 - 12.4 Code 128..... 32
 - 12.5 Chinese Post Code 33
 - 12.6 MSI/Plessy 34
 - 12.7 Interleaved 2 of 5 35
 - 12.8 UPC/EAN/JAN 36
 - 12.9 Data Editing 39
 - 12.10 Standard 2 of 5 42
 - 12.11 Industrial 2 of 5 42
- 13. Code 39 Full ASCII Table..... 43

ZBA, Inc.
94 Old Camplain Road Hillsborough, NJ 08844
Ph: 908-359-2070 Fax: 908-595-0909
Web: <http://www.zbausa.com>



ZBA Inc.

1. Instruction

This miniature CCD scan module is especially designed for embedded scanning solution. It only weights 15 grams and sized as small as a match box. There are 3 LED indicators on top allowing immediate scanning response and a test button for performance test. There are mounting holes on the back of the case reserved for quick and easy installation.

The module has a newly designed CCD scan engine with light beam bright and clear as laser beam that gives user best visual indication and its powerful high resolution CCD acts in outstanding performance.

The scanner includes key features as,

- ◆ World's smallest CCD scan module
- ◆ Industrial standard design
- ◆ A "TEST" button on top for performance testing
- ◆ Mounting holes at bottom for easy installation
- ◆ Great CCD scanning performance and have future upgradeability on firmware
- ◆ Best for embedded applications, kiosks, lottery machine, and others where space is limited.



ZBA Inc.

2. Outline

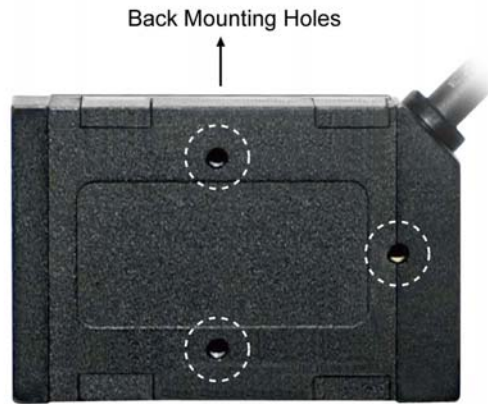

3. Mounting Recommendations

The scanner is designed to embed into any space limited devices, and it has 3 screwed mounting holes reserved at the bottom.

Screw description: M1.6

Screw quantity: 3 pieces

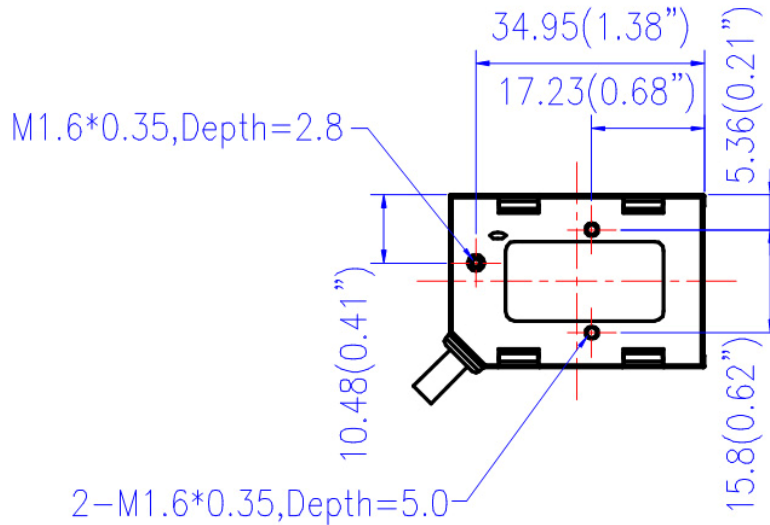

Units: mm(inch.)

Figure : Screw Position

To ensure the scanner reaches its best performance, the following points need to be noticed when mounting the scanner:

- (a) Do not place the scanner under direct sunlight or any other bright light source illuminating.
- (b) When placing the barcode label, one must be careful not to over tilt, skew and/or pitch the barcode (Refer to figure 2)
- (c) Do not place the device at specula reflection position. The LED light of the scanner reflects directly back on the scanner if it is placed at specula reflection position. As to the nature of CCD sensor, it will not be able to read any barcodes.



(d) The barcode label must be placed within the effective depth of field (D.O.F.) since it is the effective reading distance for the barcode from the scanner. For the best placing position, please refer to the Decode Depth of Field drawing. (Figure 3)

	Different quality and density of a barcode could effect its decode depth of field. Usually when a barcode has poor printing quality or high density, the depth of field would be shorter. It is highly suggested not place the barcode label at the extremes of depth of field as it is often easy to move out from the reading range.
	Test condition: using a 100% EAN 13 barcode, 0.33mm (13 mil), at a distance of 14cm (5.5") in optimal lighting conditions.

Pitch Angle: $\pm 65^\circ$ normal
Specular Reflection: $\pm 5^\circ$

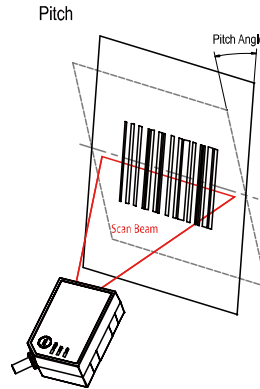

Skew Angle: $\pm 65^\circ$ normal

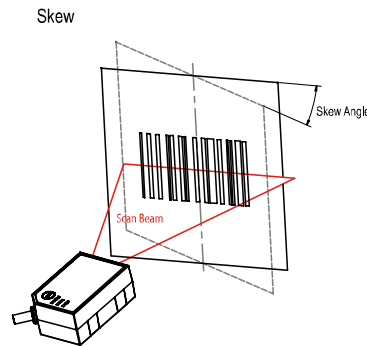



Roll Angle: $\pm 20^\circ$ normal
(Prevents reading of a barcode
if all the bars are not inside the
reading beam or if tilt is more
than 20° .)

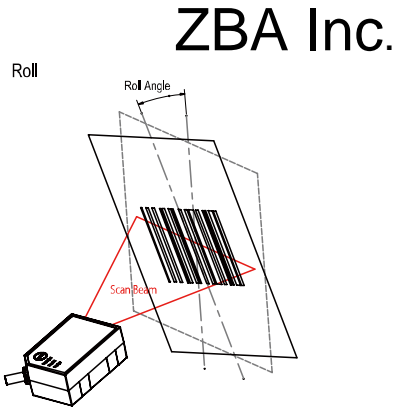

Figure 2: Skew, Pitch and Roll Angle Illustration



ZBA Inc.

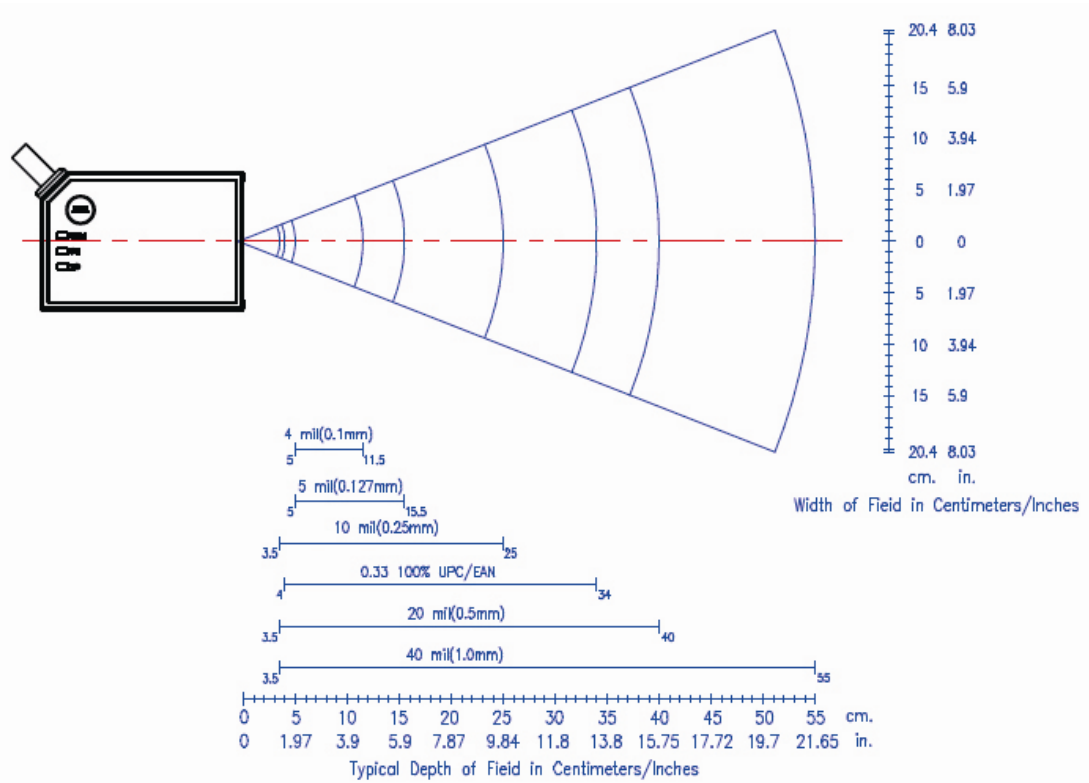

Figure 3: Decode Depth of Field



4. Interface Selection

The scan module has 3 different kinds of interface connections to suit customer's desire; the standard cable is black, straight and 2 m (6.5 feet) in length. Below shows the connector types and pin out configuration for each interface.

(a) All interface – RS-45 10P10C for multi-interface connection

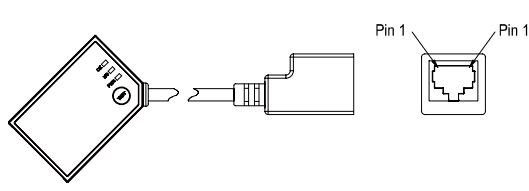

Pin #	Function
1	RTS_EIA
2	USB_D+
3	USB_D-
4	GND
5	CTS_EIA
6	RX_EIA
7	Trigger_In
8	+5V Input
9	N.C.
10	TX_EIA

(b) RS-232 interface – Power adapter required if host can not provide sufficient power.

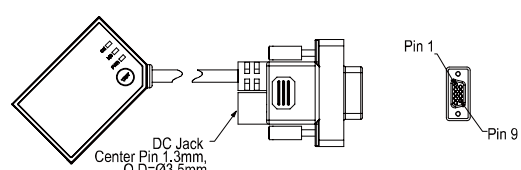

Pin #	Function
1	N.C.
2	TX_EIA
3	RX_EIA
4	N.C.
5	GND
6	N.C.
7	CTS_EIA
8	RTS_EIA
9	+5V Input
Inner of DC-Jack: +5V DC	
Outer of DC-Jack: GND	



ZBA Inc.

(c) USB interface connection

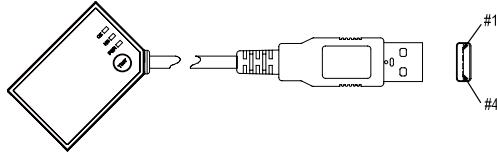

Pin #	Function
1	N.C.
2	TX_EIA
3	RX_EIA
4	N.C.



5. Blink Mode

After the scanner has been inactive for a period of time, the light beam would automatically start blinking. To stop the scanner from blinking, simply present an object close to the scanner window or press the test button. The Blink Mode feature is included to reduce power consumption and to extend scanner life. Use the barcodes in page 27 to change the blink mode settings

6. TEST Button Function

On top of the scan module, there is a “TEST” button, and it controls two function modes:

- 5-1 Trigger mode
- 5-2 Scan performance test mode

The “TEST” button can be set to function as complex modes or only single mode using the set-up barcodes below:



Start of Configuration

Scan this barcode to enter set-up process.

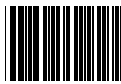

Complex modes

Scan this barcode to set-up the TEST button to control both trigger mode and scan performance test mode.



When the scanner is set in this mode, briskly and continuously press down TEST button twice to activate scan performance test function.

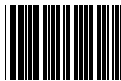

Scan this barcode and the TEST button only functions as scan performance test mode.



Scan performance test mode



When the scanner is set in this mode, continuously press down TEST button over 2 seconds to activate scan performance test function.



Trigger mode

Scan this barcode and the TEST button only functions as a trigger.



End of Configuration

Scan this barcode to save the change and exit from set-up.

12.1 5-1 Trigger Mode

In trigger mode, simply aim the scan module at the barcode and press the TEST button to trigger scan light beam and decode.

12.2 5-2 Scan Performance Test Mode

To enter into scan performance test mode, briskly and continuously press down the TEST button twice, and all LED indicators are off with two short beep sound simultaneously. The module successfully enters into the mode, and places a barcode label within its scanning range to get the best scan performance result.

The result is indicated with LED lights with different read rate as below:

Read Rate %	50%	75%	90%
OK_LED	On	On	On
NG_LED	x	On	On
PWR_LED	x	x	On

Press the TEST button once; it exits from the scan performance test mode and return to normal operation.



7. Technical Specification

<p>Power Requirement Input voltage LED on LED off Decode</p>	<p>5V \pm5% VDC 87mA typical 37mA typical 120mA typical 150mA @ 100msec Max. 250mA @ 1msec peak</p>
<p>Operational Sensor Illumination Depth of field Scan rate Minimum bar width Print contrast Indicators (LED) Beeper operation Scan angle Pitch angle Skew angle Specular reflection angle System interface</p>	<p>2,500 pixels CCD 617nm visible red LED 40 – 235mm (UPC/EAN 100%, PCS=90%) 200 scans per second 0.125mm (5mil) (0.1mm actually) (Code 39, PCS=90%, contact) 30% @ UPC/EAN 100% “OK”, “NG”, “PWR” and “TEST” Programmable tone & beep time 43° \pm65° \pm65° \pm5° RS-232C, HID USB, and USB-Virtual COM port emulation</p>
<p>Environment Operating temperature Storage temperature Humidity Ambient light immunity Shock Vibration</p>	<p>0°C ~ 50°C (32°F ~ 122°F) -20°C ~ 60°C (-4°F ~ 140°F) 5% to 95% non-condensing 7,000 Lux max. (fluorescence) 2,000G Unpowered engine withstands a random vibration along each of the X, Y and Z axis for a period of 10 min. per axis, defined as follows: <ul style="list-style-type: none"> ● 20~80Hz ramp up to 0.04G²/Hz at the rate of 3dB/oct. ● 80~350Hz 0.04G²/Hz </p>



	<ul style="list-style-type: none">• 350~2000Hz ramp down at the rate of 3dB/oct.
--	------------------------------------------------------------------------------------------------

~Technical Specification Continued~

Physical dimension Height Width Depth Weight Mounting	15.8mm (0.62") 26.6mm (1.05") 39.0mm (1.54") 15g 3-M1.6 * 0.35 screw hole
Regulatory Regulator approval	According CE, FCC, VCCI, RoHS compliant
Decode symbology	UPC/JAN/EAN, Code 39, Code 93, Codabar, Interleave 2 of 5, IATA, Standard 2 of 5, ISBN/ISSN, Chinese post code, MSI/Plessey, EAN 128, Code 128



ZBA Inc.

8. Dimension

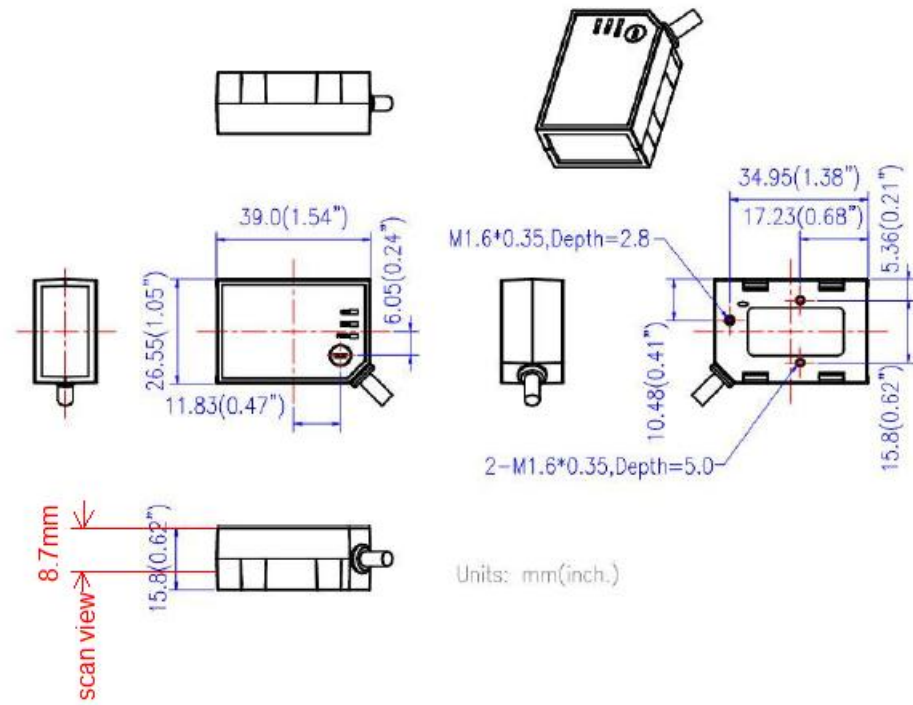



9. Maintaining the Scanner

The scanner is designed for long-term trouble-free operation and rarely requires any maintenance. Only an occasional cleaning of the scanner window is necessary in order to remove dirt and fingerprints.

Wipe the scan window with a soft lint-free cloth and a non-abrasive cleaner to avoid scratching and damaging the scan window. The scan window may be cleaned while the scanner is running.



Scratching the scanner window can reduce the scanning performance. We suggest you either recess the window into the housing or apply a hard-coat on window.



10. Programming Guide

Scanning a series of programming bar code labels can configure the scanner. This allows decoding options and interface protocols to be tailored to a specific application. The configuration is stored in non-volatile memory and will not be lost by removing power from the scanner.

The scanner must be properly powered before programming. For RS-232C type scanners, an external power adapter might be necessary to supply DC power to the scanner.

During the programming mode, the scanner will acknowledge a good and valid reading with a short beep. It will give long beeps for either an invalid or bad reading.

Table 1 gives the default settings of all the programmable parameters. The default settings will be restored whenever the "Reset" programming label is scanned.

12.3 Programming Procedure

Below is the programming procedure for using barcodes in this guide.

1. Power up the scanner.
2. Scan the **Start of Configuration** barcode.
3. Scan the barcode for the desired feature. Multiple features can be enabled/disabled before scanning the **End of Configuration** barcode.
4. Scan the **End of Configuration** barcode and save the new configuration.
5. To give up a configuration change, power off the scanner before scanning the **End of Configuration** barcode or scan the **Abort** barcode.
6. For some parameter setting, such as barcode length and identifier code, it is required to scan the **Set** barcode to save the configuration.

Default values are highlighted in gray background.

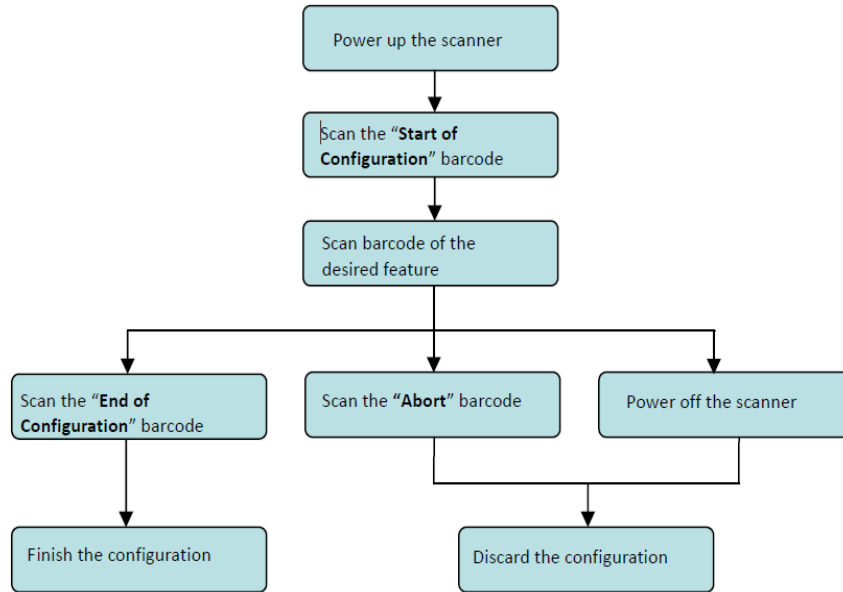



12.4 Table 1: Factory Default Settings

This table gives the default settings of all the programmable parameters. The default settings would be restored whenever the laser scanner reads the “Reset” programming label in programming mode. If you wish to change any setting, scan the appropriate barcodes below.

Scanner Timing	Default
Same code delay	500msec
Scan mode	Auto scan
RS-232 communication	Default
Baud rate	9600
Parity	none
Data bits	8
Stop bit	1
RTS/CTS	off
Terminator	<CR><LF>
USB Communication	Default
Terminator type	Enter
Code mode	Scan code
Decoder Selection	Default
EAN/UPC	Enable
CODE 39	Enable
Code 32	Disable
CODABAR	Enable
ITF 2 OF 5	Enable
MSI/Plessey	Disable
Chinese post code	Disable
Code 93	Enable
Code 128	Enable
EAN-128	Disable
Standard 2 of 5	Disable
NEC 2 of 5	Disable
Beeper sound	Default
Frequency	High
Duration	100msec
Code Identifiers	Default
Code ID	Off
Code 39 identifier	M



ITF 2 of 5 identifier	I
Chinese post code identifier code	H
UPC-A identifier code	A
UPC-E identifier code	E
EAN-13 identifier code	F

EAN-8 identifier code	FF
Codabar identifier code	N
Code 128 identifier code	K
Code 93 identifier code	L
MSI identifier code	P
Standard 2 of 5 identifier code	S
NEC 2 of 5 identifier code	G
LED/Beep transmission	Default
LED/beep before transmission	On

12.5 Table 2: Default Data Transmit Format

Code	Message format
EAN-13	D1 D2 D3 D4 D5 D6 D7 D8 D9 D10 D11 D12 D13
EAN-8	D1 D2 D3 D4 D5 D6 D7 D8
UPCA	D1 D2 D3 D4 D5 D6 D7 D8 D9 D10 D11 D12
UPCE	D1 D2 D3 D4 D5 D6 D7 D8
Code 128	D1-Dx (default 3~32)
EAN 128	C1 D1-Dx (default 3~32)
Code 39	D1-Dx (default 3~32)
Code 32	D1-Dx (default 3~32)
CODABAR	D1-Dx (default 6~32)
Interleaved 2 of 5	D1-Dx (default 6~32)
Chinese Post Code	D1-Dx (default 8~32)
Code 93	D1-Dx (default 3~32)
MSI	D1-Dx (default 6~32)
Coop 2 of 5	D1-Dx (default 6~32)



**12.6 Table 3: Trigger Command Format
(Only for RS-232C and USB-Virtual COM Port)**

Command	Description
<ESC>A0<CR>	Level trigger command; scan off when trigger off command
<ESC>A1<CR>	Trigger off command
<ESC>A0.mm<CR> mm=1~60(Sec)	Edge trigger command It is not controlled by the trigger off command. Scanner starts next scan if it receives an edge trigger command and the device remains "mm" time.
<ESC>A2<CR>	Scan once (same as trigger mode)
<ESC>A2.xx<CR>	Scan once (scan off when time out)
NG LED When no read function is active, the LED indicates simultaneously.	



11.Parameter setting



Default settings are highlighted in gray background.



Start Of Configuration
- Scan this barcode to enter set-up process.

11.1. System Function Setting



Reset
- Returns Parameters to default settings
Note: Does not change interface setting



Display firmware version



Return as customer default



Save as customer default



Abort
-Exit programming mode(no update)



Power-up beeper tone enable



Power-up beeper tone disable



Speaker Disable



End Of Configuration



Start Of Configuration
- Scan this barcode to enter set-up process.



High beeper tone



Medium beeper tone



Low beeper tone



Loud volume



Medium volume



Slight volume



Good read beep sound duration (500msec)



Good read beep sound duration (200msec)



Good read beep sound duration (100msec)



Good read beep sound duration (50msec)



Good read beep sound duration (20msec)



Good read beep sound duration (5msec)



LED/Beep after transmission
- indicate a "good read" after a barcode is successfully decoded.



LED/Beep before transmission
- indicate a "good read" after successfully transmitting the barcode data to the host.



End Of Configuration



11.2. Scan Function Setting



Start Of Configuration

- Scan this barcode to enter set-up process.



Trigger mode

- The scanner becomes inactive as soon as the data is transmitted. It must be triggered to active again.



Auto scan mode

- The light beam is active always, and the same barcode can not be read twice in this mode.



Alternate mode

- The light beam active when press the trigger and turns off till next triggering.



Repeat mode

- It is similar to auto scan mode, but double reading on the same barcode is permitted if uses trigger.

11.3. “TEST” Button Function Setting



Complex mode

- Scan this barcode to set-up the test button to control both trigger mode and scan performance test mode.



Scan performance test mode only

- Scan this barcode and the test button only functions as scan performance test mode.
- Press down “TEST” button continuously over 2 seconds and it starts to perform scan test.



Trigger mode only

- Scan this barcode and the test button only functions as a trigger.





End Of Configuration



11.4. Interface Setting

 Start Of Configuration

 Enable USB-Virtual COM port

 Enable HID USB keyboard

 Enable RS-232 communication

11.5. HID USB Keyboard Wedge Setting

 Enable Alt mode

 Keyboard language support - USA

 Keyboard language support - Japan

 Capital lock on

 Capital lock off

 Function key emulation enable

 Function key emulation disable

 Send number as normal data

 Send number as keypad data

 End Of Configuration



Start Of Configuration



Alphabet follow as keyboard



Alphabet always upper case



Alphabet always lower case



Keyboard terminator - none



Keyboard terminator - enter



Keyboard terminator – H. Tab

11.6. RS-232 Interface Setting



Baud Rate
Baud rate 115200



Baud rate 57600



Baud rate 38400



Baud rate 19200



Baud rate 9600



Baud rate 4800



End Of Configuration



Start Of Configuration

Baud Rate (Continued)



Baud rate 2400



Baud rate 1200



Baud rate 600



Baud rate 300

Parity



Even parity



Odd parity



Mark parity



Space parity



None parity

Stop Bit



1 stop bit



2 stop bit

Data Bit



7 data bit



8 data bit



End Of Configuration



Start Of Configuration

Handshaking



No handshaking



ACK/NAK



Xon/Xoff



RTS/CTS (Character handshaking)



Standard CTS polarity

- high=inactive, do not send,
- low=active, do not send



Invert CTS polarity

- High=active, OK to send
- Low=inactive, do not send



Active RTS, do not wait for CTS



Active RTS, wait for CTS



RTS/CTS message handshaking



Enable beeper ON <BEL> character



Ignore beeper ON <BEL> character



ACK/NAK response time 500ms



ACK/NAK response time 300ms



ACK/NAK response time 5s



ACK/NAK response time 3s



ACK/NAK response time 2s



ACK/NAK response time 1s



ACK/NAK response time infinity



End Of Configuration



Start Of Configuration

Message Terminator



RS-232 message terminator – none



RS-232 message terminator – CR/LF



RS-232 message terminator – CR



RS-232 message terminator – LF



RS-232 message terminator – H tab



RS-232 message terminator – STX/ETX



RS-232 message terminator – EOT



End Of Configuration



12.The Symbologies Settings

12.1 Codabar



Start Of Configuration



Codabar enable



Codabar disable



Codabar start/stop character transmission – None



Codabar start/stop character transmission – A,B,C,D



Codabar start/stop character transmission – DC1-DC4



Codabar start/stop character transmission – a/t, b/n, c/*, d/e



Codabar maximum length setting



Codabar minimum length setting



Save setting to confirm (for length setting)



Codabar concatenation disable



Codabar concatenation enable



No check character



Validate modulo 16, but don't transmit



Validate modulo 16, but transmit



Codabar data redundant check=off



Codabar data redundant check=1



Codabar data redundant check=2



Codabar data redundant check=3



End Of Configuration



12.2 Code 39



Start Of Configuration



Code 39 enable



Code 39 disable



Code 32 enable



Code 32 disable



Code 39 data redundant check=off



Code 39 data redundant check=1



Code 39 data redundant check=2



Code 39 data redundant check=3



Standard code 39



Full ASCII code 39



Code 39 start/stop character transmission



Code 39 start/stop character without transmission



Code 39 check digit calculate and transmit



Code 39 check digit calculate but without transmit



No check character



Code 39 maximum length setting



Code 39 minimum length setting



Save setting to confirm (for length setting)



Code 39 (Continued)



Start Of Configuration



Code 39 concatenation enable



Code 39 concatenation disable



Code 32 (Italian pharmacy) transmit "A" character











Code 32 (Italian pharmacy) without transmit "A" character







End Of Configuration





















12.3 Code 93

-  Start Of Configuration
-  Code 93 enable
-  Code 93 disable
-  Code 93 data redundant check=off
-  Code 93 data redundant check=1
-  Code 93 data redundant check=2
-  Code 93 data redundant check=3
-  Code 93 maximum length setting
-  Code 93 minimum length setting

	Save setting to confirm (for length setting)
	Code 93 check digit calculated but without transmit
	Code 93 check digit not calculated and without transmit
	Code 93 check digit calculated and transmit
	End Of Configuration



12.4 Code 128

	Start Of Configuration
	Code 128 enable
	Code 128 disable
	EAN-128 enable
	EAN-128 disable
	Code 128 data redundant check=off
	Code 128 data redundant check=1
	Code 128 data redundant check=2
	Code 128 data redundant check=3
	Code128 FNC2 concatenation enable
	Code128 FNC2 concatenation disable
	No check character
	Calculate but not transmit
	Calculate and transmit
	Code 128 maximum length setting
	Code 128 minimum length setting
	Save setting to confirm (for length setting)
<hr/>	
	End Of Configuration



12.5 Chinese Post Code

	Start Of Configuration
	Chinese post code enable
	<u>Chinese post code disable</u>
	Chinese post code data redundant check=off
	<u>Chinese post code data redundant check=1</u>
	Chinese post code data redundant check=2
	Chinese post code data redundant check=3
	Chinese post code maximum length setting
	Chinese post code minimum length setting
	<u>Chinese post code no check digit</u>
	Chinese post code check digit calculate and transmit
	Chinese post code check digit calculate but without transmit
	
	
	Save setting to confirm (for length setting)
	
	End Of Configuration



12.6 MSI/Plessey

	Start Of Configuration
	MSI enable
	MSI disable
	MSI data redundant check= off
	MSI data redundant check=1
	MSI data redundant check=2
	MSI data redundant check=3
<hr/>	
	MSI/PLESSY maximum length setting
<hr/>	
	MSI/PLESSY minimum length setting
<hr/>	
	Save setting to confirm (for length setting)
<hr/>	
	MSI/Plessey double check digit calculate but not transmit
<hr/>	
	MSI/Plessey double check digit without calculate and transmit
<hr/>	
	MSI/Plessey double check digit calculate but only first digit transmit
<hr/>	
	MSI/Plessey double check digit calculate and both transmit
<hr/>	
	MSI/Plessey single check digit calculate but without transmit
<hr/>	
	MSI/Plessey single check digit calculate and transmit
<hr/>	
	End Of Configuration
<hr/>	



12.7 Interleaved 2 of 5



Start Of Configuration



ITF 2 of 5 enable



ITF 2 of 5 disable



IATA code enable



IATA disable



ITF 2 of 5 data redundant check=off



ITF 2 of 5 data redundant check=1



ITF 2 of 5 data redundant check=2



ITF 2 of 5 data redundant check=3



ITF 2 of 5 code maximum length setting



ITF 2 of 5 code minimum length setting



ITF 2 of 5 no check character



ITF 2 of 5 check digit calculate and transmit



ITF 2 of 5 check digit calculate but without transmit



ITF 2 of 5 one fixed length setting



ITF 2 of 5 two fixed length setting



End Of Configuration



12.8 UPC/EAN/JAN

	Start Of Configuration
	EAN convert to ISSN/ISBN enable
	EAN convert to ISSN/ISBN disable
	UPC/EAN/JAN enable
	UPC/EAN/JAN disable
	UPC/EAN/JAN all enable
	EAN-8 or EAN-13 enable
	UPC-A and EAN-13 enable
	UPC-A and UPC-E enable
	UPC-A enable
	UPC-E enable
	EAN-13 enable
	EAN-8 enable
	UPC/EAN add on off
	Add on 5 only
	Add on 2 only
	Add on 2 or 5
	Force UPC-E to UPC-A format enable
	Force UPC-E to UPC-A format disable
	Force UPC-A to EAN-13 format enable
	End Of Configuration



UPC/EAN/JAN (Continued)



Start Of Configuration



Force UPC-A to EAN-13 format disable



Transmit UPC-A check digit enable



Transmit UPC-A check digit disable



Transmit UPC-E leading character enable



Transmit UPC-E leading character disable



Transmit UPC-E check digit enable



Transmit UPC-E check digit disable



Transmit EAN-8 check digit enable



Transmit EAN-8 check digit disable



Transmit EAN-13 check digit enable



Transmit EAN-13 check digit disable



Transmit UPC-A leading character enable



Transmit UPC-A leading character disable



Add on format with separator



Add on format without separator



EAN/UPC +add on (none mandatory)



End Of Configuration



UPC/EAN/JAN (Continued)



Start Of Configuration

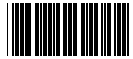

EAN/UPC +add on (mandatory)



Force EAN-8 to EAN-13 format enable



Force EAN-8 to EAN-13 format disable



EAN-13 first "0" can transmitted



EAN-13 first:"0" can't transmitted



EAN-13 with first 0 ID code same as "UPC-A"



EAN-13 with first 0 ID code same as "EAN-13"



EAN/UPC +add on mandatory 491 Japanese (bookland) Supplement requirement, optionally for other



EAN/UPC +add on mandatory for 491 Japanese (bookland) Supplement requirement, not sent for other

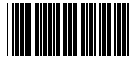

EAN/UPC +add on mandatory for 978/977 (bookland)



Supplement requirement, optionally for other EAN/UPC +add on mandatory for 978/977 (bookland)



Supplement requirement, not sent for other

End Of Configuration



12.9 Data Editing



Start Of Configuration



Code 39 identifier code setting



ITF 2 of 5 identifier code setting



Chinese Post Code identifier code setting



UPC-E identifier code setting



UPC-A identifier code setting



EAN-13 identifier code setting



EAN-8 identifier code setting



Codabar identifier code setting



Code 128 identifier code setting



Code 93 identifier code setting



MSI identifier code setting



Standard 2 of 5 identifier code setting



Coop 2 of 5 identifier code setting (For specific model only)



Save setting to confirm (for length setting)



End Of Configuration



Data Editing (Continued)



Start Of Configuration



Add code length as header enable (all barcode)



Add code length as header disable (all barcode)



Header (preamble)



Trailer (postamble)



Save setting to confirm (for length setting)



Truncate header character



Truncate trailer character



Inter character delay 100ms



Inter character delay 90ms



Inter character delay 50ms



Inter character delay 20ms



Inter character delay 10ms



End Of Configuration



Data Editing (Continued)



Start Of Configuration



Inter character delay 5ms



Inter character delay 2ms



Inter character delay 0ms



Inter message delay 1000ms



Inter message delay 500ms



Inter message delay 100ms



Inter message delay 0ms



Disable identifier code











Enable identifier code table as manufacturer standard









End Of Configuration



12.10 Standard 2 of 5

-  Start Of Configuration
-  Standard 2 of 5 code enable
-  Standard 2 of 5 code disable
-  Standard 2 of 5 code maximum length setting
-  Standard 2 of 5 code minimum length setting
-  Standard 2 of 5 code no check character
-  Standard 2 of 5 code check digit calculate and transmit
-  Standard 2 of 5 code check digit calculate but without transmit

12.11 Industrial 2 of 5

-  Industrial 2 of 5 code enable
-  Industrial 2 of 5 code disable
-  Industrial 2 of 5 code maximum length setting
-  Industrial 2 of 5 code minimum length setting
-  Industrial 2 of 5 code no check character
-  Industrial 2 of 5 code check digit calculate and transmit
-  Industrial 2 of 5 code check digit calculate but without transmit

 End Of Configuration



13.Code 39 Full ASCII Table



Start Of Configuration

Code 39 Full ASCII Table

Code 39	ASCII	Hexa-code	Code 39	ASCII	Hexa-code
	Full ASCII ---NUL	00		Full ASCII ---SI Function key----"Shift"	0F
	Full ASCII ---SOH Function key----"Ins"	01		Full ASCII ---DLE Function key----"5(num)"	10
	Full ASCII ---STX Function key----"Del"	02		Full ASCII ---DC1 Function key----"F1"	11
	Full ASCII ---ETX Function key----"Home"	03		Full ASCII ---DC2 Function key----"F2"	12
	Full ASCII ---EOT Function key----"End"	04		Full ASCII ---DC3 Function key----"F3"	13
	Full ASCII ---ENQ Function key----"Up arrow"	05		Full ASCII ---DC4 Function key----"F4"	14
	Full ASCII ---ACK Function key----"Down arrow"	06		Full ASCII ---NAK Function key----"F5"	15
	Full ASCII ---BEL Function key----"Left arrow"	07		Full ASCII ---SYN Function key----"F6"	16
	Full ASCII ---BS Function key----"Backspace"	08		Full ASCII ---ETB Function key----"F7"	17
	Full ASCII ---HT Function key----"TAB"	09		Full ASCII ---CAN Function key----"F8"	18
	Full ASCII ---LF Function key----"Enter (alpha numeric)"	0A		Full ASCII ---EN Function key----"F9"	19
	Full ASCII ---VT Function key----"right arrow"	0B		Full ASCII ---SUB Function key----"F10"	1A
	Full ASCII ---FF Function key----"PgUp"	0C		Full ASCII ---ESC Function key----"F11"	1B
	Full ASCII ---CR Function key----"Enetr(num.)"	0D		Full ASCII ---FS Function key----"F12"	1C
	Full ASCII ---SO Function key----"PgDn"	0E		Full ASCII ---GS Function key----"ESC"	1D



End Of Configuration



Start Of Configuration

Code 39 Full ASCII Table (Continued)

Code 39	ASCII	Hexa-code	Code 39	ASCII	Hexa-code
	Full ASCII ---RS Function key-----“CTL(L)”	1E		Full ASCII ----	2D
	Full ASCII ---US Function key-----“ALT(L)”	1F		Full ASCII ---.	2E
	Full ASCII ---SP	20		Full ASCII ---/	2F
	Full ASCII ---!	21		Full ASCII ---0	30
	Full ASCII ---“	22		Full ASCII ---1	31
	Full ASCII ---#	23		Full ASCII ---2	32
	Full ASCII ---\$	24		Full ASCII ---3	33
	Full ASCII ---%	25		Full ASCII ---4	34
	Full ASCII ---&	26		Full ASCII ---5	35
	Full ASCII ---‘	27		Full ASCII ---6	36
	Full ASCII --- (28		Full ASCII ---7	37
	Full ASCII ---)	29		Full ASCII ---8	38
	Full ASCII ---*	2A		Full ASCII ---9	39
	Full ASCII ---+	2B		Full ASCII ---:	3A
	Full ASCII ---,	2C		Full ASCII ---;	3B



End Of Configuration



Start Of Configuration

Code 39 Full ASCII Table (Continued)

Code 39	ASCII	Hexa-code	Code 39	ASCII	Hexa-code
	Full ASCII ---RS Function key-----"CTL(L)"	1E		Full ASCII ----	2D
	Full ASCII ---US Function key-----"ALT(L)"	1F		Full ASCII ---.	2E
	Full ASCII ---SP	20		Full ASCII ---/	2F
	Full ASCII ---!	21		Full ASCII ---0	30
	Full ASCII ---"	22		Full ASCII ---1	31
	Full ASCII ---#	23		Full ASCII ---2	32
	Full ASCII ---\$	24		Full ASCII ---3	33
	Full ASCII ---%	25		Full ASCII ---4	34
	Full ASCII ---&	26		Full ASCII ---5	35
	Full ASCII ---'	27		Full ASCII ---6	36
	Full ASCII --- (28		Full ASCII ---7	37
	Full ASCII ---)	29		Full ASCII ---8	38
	Full ASCII ---*	2A		Full ASCII ---9	39
	Full ASCII ---+	2B		Full ASCII ---:	3A
	Full ASCII ---,	2C		Full ASCII ---;	3B



End Of Configuration



Start Of Configuration

Code 39 Full ASCII Table (Continued)

Code 39	ASCII	Hexa-code	Code 39	ASCII	Hexa-code
	Full ASCII ---<	3C		Full ASCII ---K	4B
	Full ASCII ---=	3D		Full ASCII ---L	4C
	Full ASCII --->	3E		Full ASCII ---M	4D
	Full ASCII ---?	3F		Full ASCII ---N	4E
	Full ASCII ---@	40		Full ASCII ---O	4F
	Full ASCII ---A	41		Full ASCII ---P	50
	Full ASCII ---B	42		Full ASCII ---Q	51
	Full ASCII ---C	43		Full ASCII ---R	52
	Full ASCII ---D	44		Full ASCII ---S	53
	Full ASCII ---E	45		Full ASCII ---T	54
	Full ASCII ---F	46		Full ASCII ---U	55
	Full ASCII ---G	47		Full ASCII ---V	56
	Full ASCII ---H	48		Full ASCII ---W	57
	Full ASCII ---I	49		Full ASCII ---X	58
	Full ASCII ---J	4A		Full ASCII ---Y	59



End Of Configuration



Start Of Configuration

Code 39 Full ASCII Table (Continued)

Code 39	ASCII	Hexa-code	Code 39	ASCII	Hexa-code
	Full ASCII ---Z	5A		Full ASCII ---i	69
	Full ASCII ---[5B		Full ASCII ---j	6A
	Full ASCII ---\	5C		Full ASCII ---k	6B
	Full ASCII ---]	5D		Full ASCII ---l	6C
	Full ASCII ---^	5E		Full ASCII ---m	6D
	Full ASCII ---_	5F		Full ASCII ---n	6E
	Full ASCII ---`	60		Full ASCII ---o	6F
	Full ASCII ---a	61		Full ASCII ---p	70
	Full ASCII ---b	62		Full ASCII ---q	71
	Full ASCII ---c	63		Full ASCII ---r	72
	Full ASCII ---d	64		Full ASCII ---s	73
	Full ASCII ---e	65		Full ASCII ---t	74
	Full ASCII ---f	66		Full ASCII ---u	75
	Full ASCII ---g	67		Full ASCII ---v	76
	Full ASCII ---h	68		Full ASCII ---w	77



End Of Configuration



Start Of Configuration

Code 39 Full ASCII Table (Continued)

Code 39	ASCII	Hexa-code	Code 39	ASCII	Hexa-code
	Full ASCII ---x	78		Full ASCII ---	7C
	Full ASCII ---y	79		Full ASCII ---}	7D
	Full ASCII ---z	7A		Full ASCII ---~	7E
	Full ASCII ---{	7B		Full ASCII ---DEL	7F



End Of Configuration



ZBA Inc.

Notes